

InGaAs PIN photodiodes

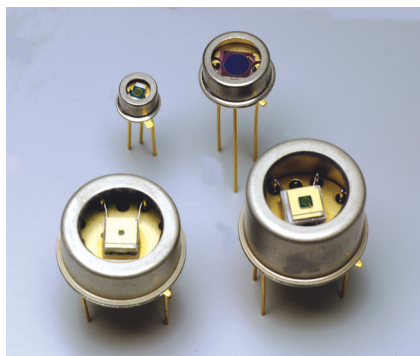

G12183 series

Long wavelength type (cutoff wavelength: 2.55 to 2.6 μm)

Features

- Cutoff wavelength: 2.55 to 2.6 μm
- Low cost
- Photosensitive area: $\phi 0.3$ to $\phi 3$ mm
- Low noise
- High sensitivity
- High reliability
- High-speed response

Applications

- Optical power meters
- Gas analyzers
- Moisture meters
- NIR (near infrared) photometry

Options

- Amplifier for InGaAs PIN photodiode **C4159-03**
- Heatsink for one-stage TE-cooled type **A3179**
- Heatsink for two-stage TE-cooled type **A3179-01**
- Temperature controller for TE-cooled type **C1103-04**

Structure / Absolute maximum ratings

Type no.	Dimensional outline /Window material*1	Package	Cooling	Photosensitive area (mm)	Absolute maximum ratings						
					Thermister power dissipation (mW)	TE-cooler allowable current (A)	TE-cooler allowable voltage (V)	Reverse voltage Vr max (V)	Operating temperature Topr (°C)	Storage temperature Tstg (°C)	Soldering conditions
G12183-003K	(1)/B	TO-18	Non-cooled	$\phi 0.3$	-	-	-	-	-40 to +85*2	-55 to +125*2	260 °C or less, within 10 s
G12183-005K				$\phi 0.5$							
G12183-010K				$\phi 1$							
G12183-020K	(2)/B	TO-5	Non-cooled	$\phi 2$	-	-	-	-	-40 to +85*2	-55 to +125*2	
G12183-030K				$\phi 3$							
G12183-103K				(3)/B							
G12183-105K	$\phi 0.5$										
G12183-110K	$\phi 1$										
G12183-120K	$\phi 2$										
G12183-130K	$\phi 3$										
G12183-203K	(4)/B	TO-8	Two-stage TE-cooled	$\phi 0.3$	0.2	1.0	1.2	1	-40 to +70*2	-55 to +85*2	
G12183-205K				$\phi 0.5$							
G12183-210K				$\phi 1$							
G12183-220K				$\phi 2$							
G12183-230K				$\phi 3$							

Note: Exceeding the absolute maximum ratings even momentarily may cause a drop in product quality. Always be sure to use the product within the absolute maximum ratings.

*1: B=Borosilicate glass

*2: No condensation

The G12183 series may be destroyed or deteriorated by electrostatic discharge, etc. Be carefull when using the G12183 series.

Electrical and optical characteristics (Typ., unless otherwise noted)

Type no.	Measurement Condition		Spectral response range λ (μm)	Peak sensitivity wavelength λ_p (μm)	Photo-sensitivity S $\lambda=\lambda_p$ (A/W)		Dark current I _D V _R =0.5 V (μA)		Temp. coefficient of I _D V _R =0.5 V	Cutoff frequency f _c V _R =0 V R _L =50 Ω (MHz)		Terminal capacitance C _t V _R =0 V f=1 MHz (pF)		Shunt resistance R _{sh} V _R =10 mV (k Ω)		Detectivity D* $\lambda=\lambda_p$ (cm ² Hz ^{1/2} /W)		Noise equivalent power NEP $\lambda=\lambda_p$ (W/Hz ^{1/2})											
	Element temperature (°C)				Min. (A/W)	Typ. (A/W)	Typ. (μA)	Max. (μA)		Min. (MHz)	Typ. (MHz)	Typ. (pF)	Max. (pF)	Min. (k Ω)	Typ. (k Ω)	Min. (cm ² Hz ^{1/2} /W)	Typ. (cm ² Hz ^{1/2} /W)	Typ. (W/Hz ^{1/2})	Max. (W/Hz ^{1/2})										
G12183-003K	25	0.9 to 2.6			1	1.3	1.035			20	50	50	100	20	100	3 × 10 ¹⁰	9 × 10 ¹⁰			4 × 10 ⁻¹³	9 × 10 ⁻¹³								
G12183-005K																				1	10	5	20	140	300	10	50	5 × 10 ⁻¹³	1.5 × 10 ⁻¹²
G12183-010K																				3	30	2	6	500	1000	2.8	14	1 × 10 ⁻¹²	3 × 10 ⁻¹²
G12183-020K																				10	100	1	1.5	1800	3000	0.65	3	2 × 10 ⁻¹²	5 × 10 ⁻¹²
G12183-030K																				30	300	0.5	0.8	4000	5000	0.25	1.4	3 × 10 ⁻¹²	8 × 10 ⁻¹²
G12183-103K	-10	0.9 to 2.57	2.3		1	1.3	1.035			20	70	44	100	200	1000	1 × 10 ¹¹	3 × 10 ¹¹			1 × 10 ⁻¹³	3 × 10 ⁻¹³								
G12183-105K																				0.12	1.2	5	25	120	300	100	500	1.5 × 10 ⁻¹³	4.5 × 10 ⁻¹³
G12183-110K																				0.3	3	2	7	440	1000	28	140	2.5 × 10 ⁻¹³	8 × 10 ⁻¹³
G12183-120K																				0.9	9	1	2	1500	3000	6.5	30	5.5 × 10 ⁻¹³	2 × 10 ⁻¹²
G12183-130K																				3	30	0.5	0.9	3400	5000	2.8	14	8.5 × 10 ⁻¹³	2.5 × 10 ⁻¹²
G12183-203K	-20	0.9 to 2.55			1	1.3	1.035			20	75	40	100	400	2000	1.5 × 10 ¹¹	4.5 × 10 ¹¹			7 × 10 ⁻¹⁴	2 × 10 ⁻¹³								
G12183-205K																				0.085	0.85	5	28	110	300	200	1000	1 × 10 ⁻¹³	3 × 10 ⁻¹³
G12183-210K																				0.21	2.1	2	8	400	1000	55	280	2 × 10 ⁻¹³	5.5 × 10 ⁻¹³
G12183-220K																				0.65	6.5	1	2.3	1400	3000	13	60	4 × 10 ⁻¹³	1 × 10 ⁻¹²
G12183-230K																				2.1	21	0.5	1	3200	5000	5.5	28	6 × 10 ⁻¹³	2 × 10 ⁻¹²

Spectral response

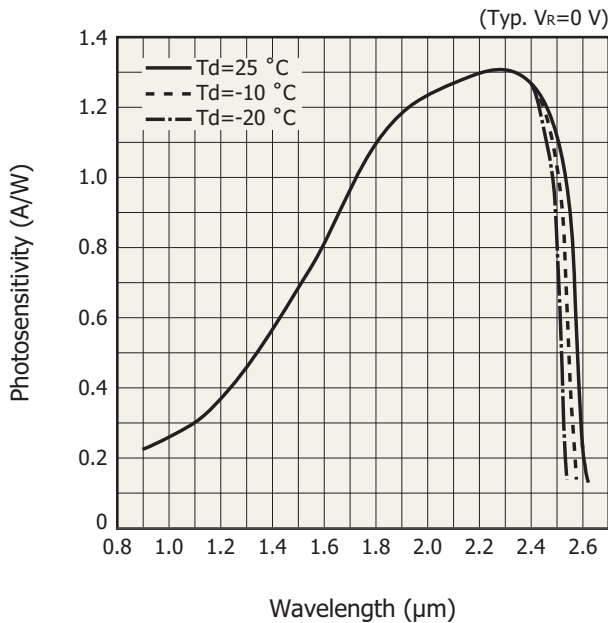

KIRD80491EC

Photosensitivity temperature characteristics

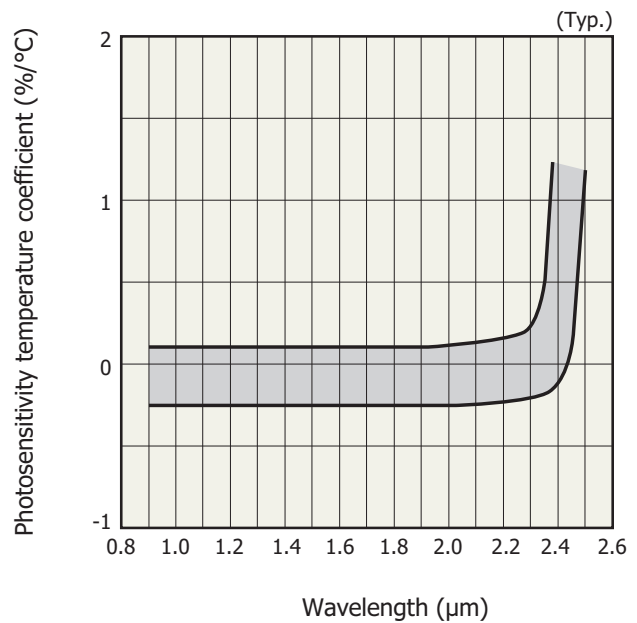

KIRD80206EA

Linearly (G12183-010K)

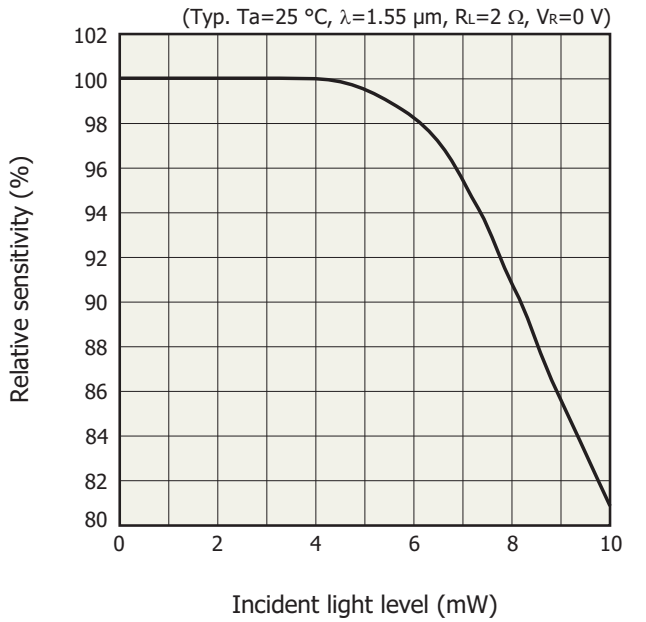

Dark current vs. reverse voltage

Non-cooled type

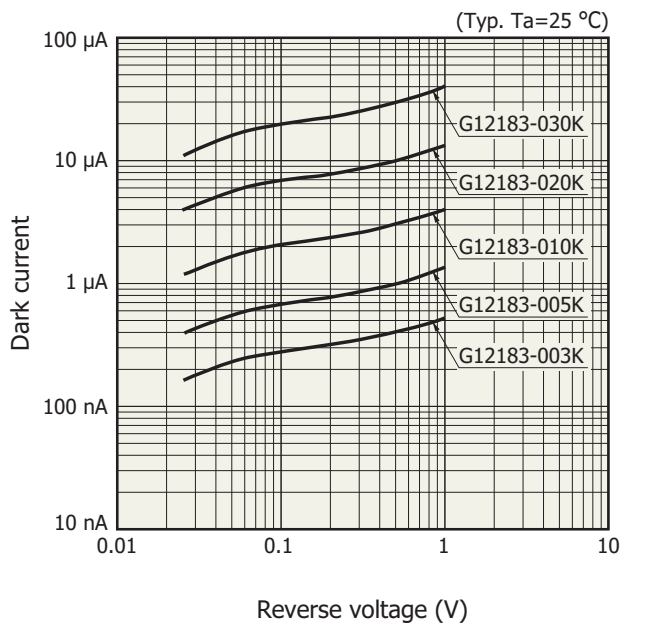

TE-cooled type

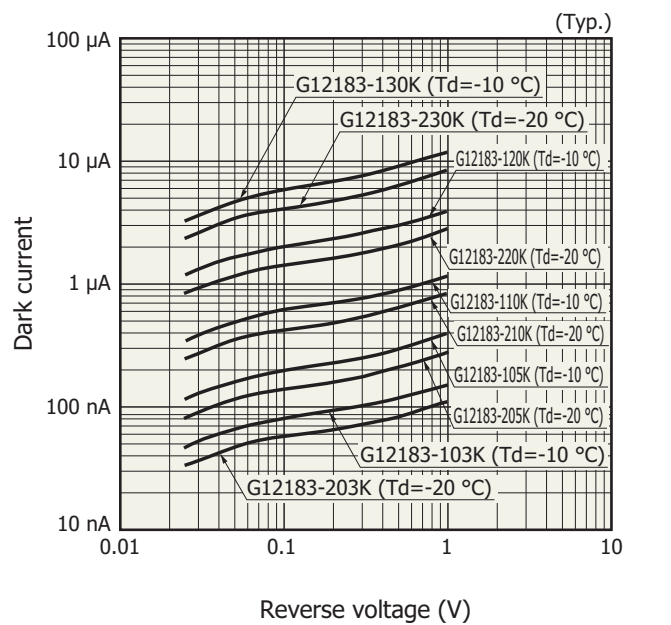

Terminal capacitance vs. reverse voltage

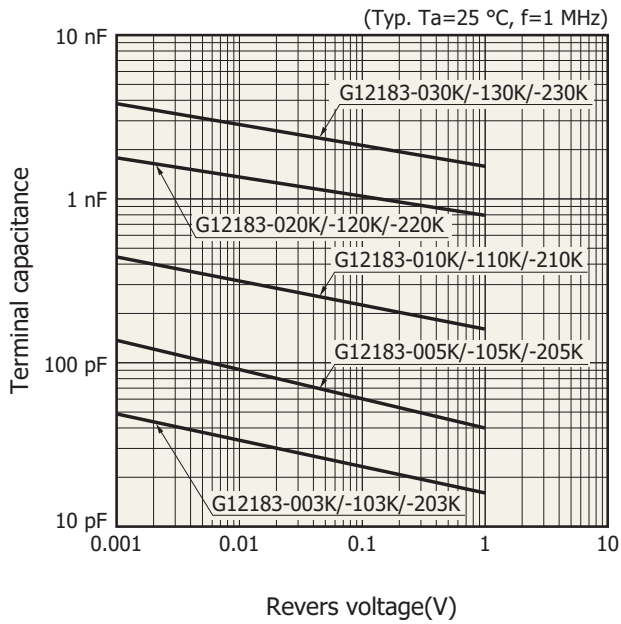

KIRD80493EB

Shunt resistance vs. element temperature

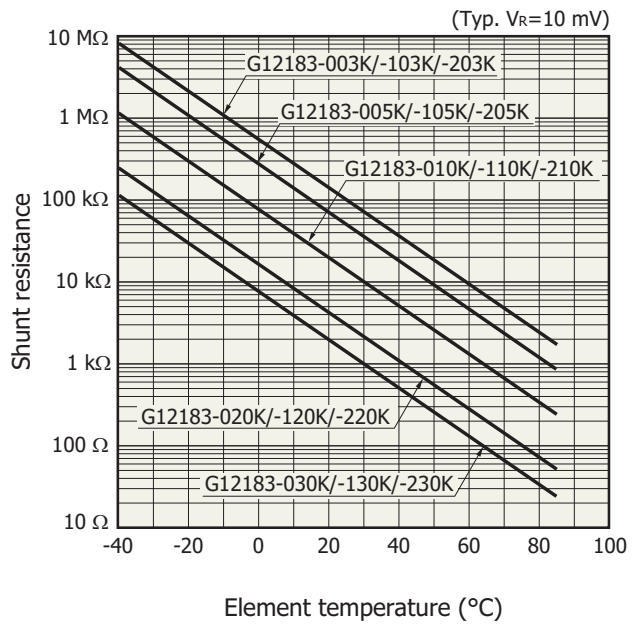

KIRD80494EB

The operating temperature for one-stage and two-stage TE-cooled types is up to 70 $^\circ\text{C}$.

Thermistor temperature characteristics

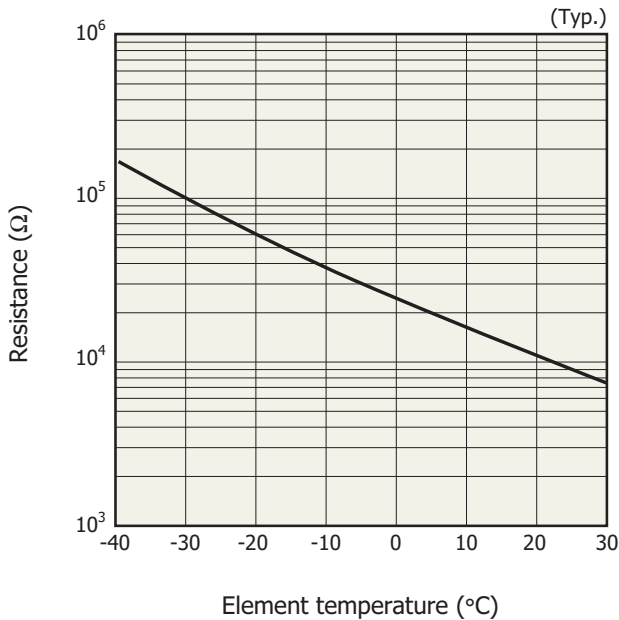

KIRD80116EA

Cooling characteristics of TE-cooler

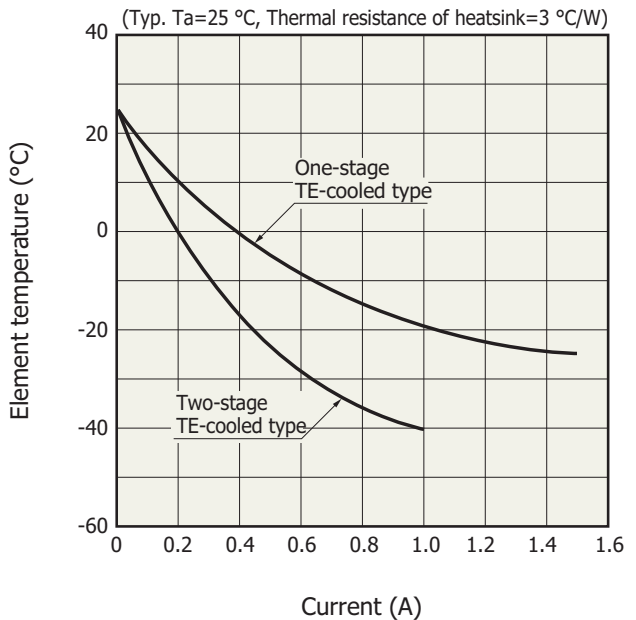

KIRD80231EA

Current vs. voltage (TE-cooler)

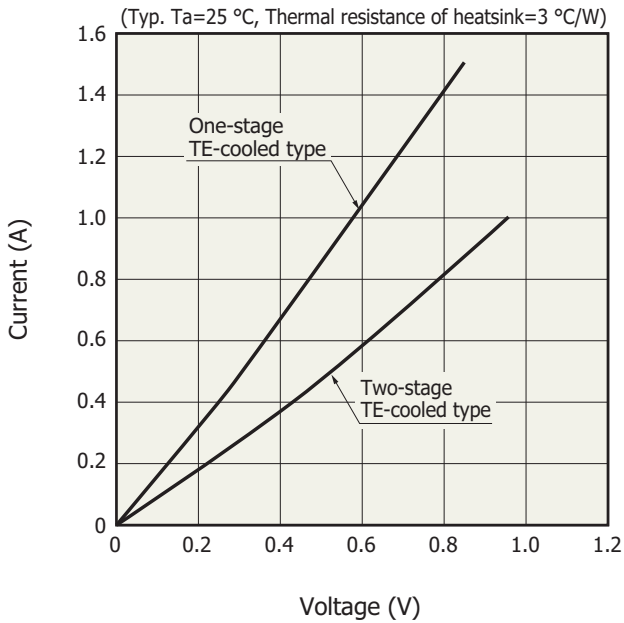

KIRD80115EB

Dimensional outlines (unit: mm)

(1) G12183-003K/-005K/-010K

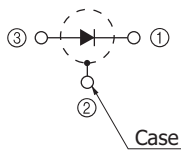
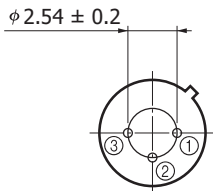
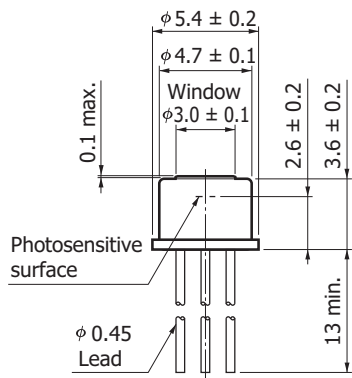

Distance from photosensitive area center to cap center
 $-0.2 \leq X \leq +0.2$
 $-0.2 \leq Y \leq +0.2$

KIRDA0220EA

(2) G12183-020K/-030K

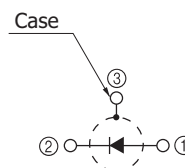
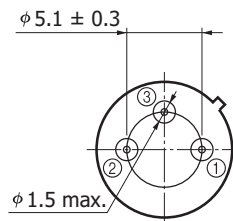
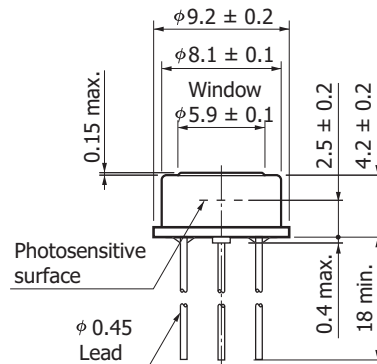

Distance from photosensitive area center to cap center
 $-0.2 \leq X \leq +0.2$
 $-0.2 \leq Y \leq +0.2$

KIRDA0221EA

(3) G12183-103K/-105K/-110K/-120K/-130K

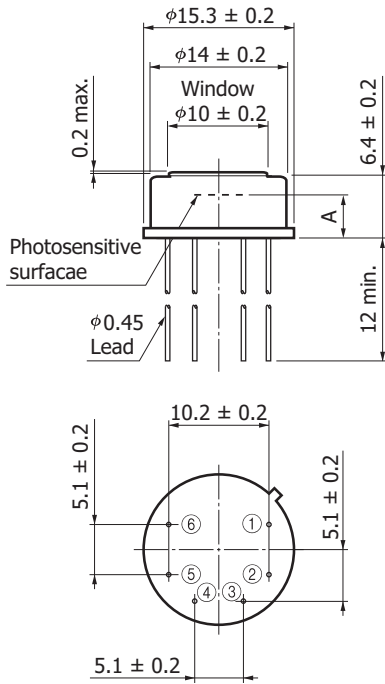

- ① Detector (anode)
- ② Detector (cathode)
- ③ TE-cooler (-)
- ④ Te-cooler (+)
- ⑤⑥ Thermistor

Distance from photosensitive area center to cap center
 $-0.3 \leq X \leq +0.3$
 $-0.3 \leq Y \leq +0.3$

	G12183-103K /-105K/110K	G12183-120K /-130K
A	4.3 ± 0.2	4.4 ± 0.2

KIRDA0228EA

(4) G12183-203K/-205K/-210K/-220K/-230K

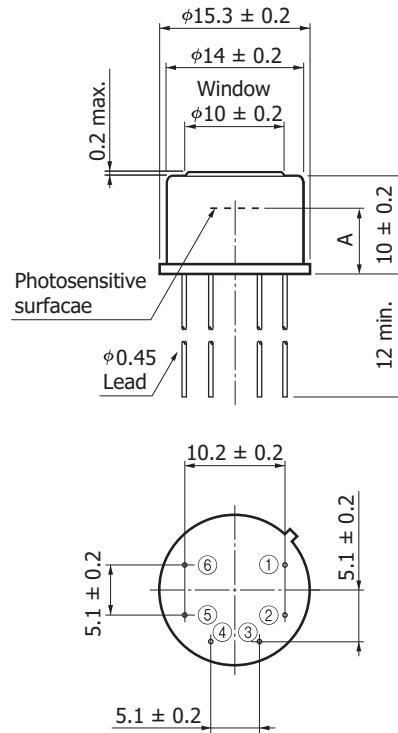

- ① Detector (anode)
- ② Detector (cathode)
- ③ TE-cooler (-)
- ④ Te-cooler (+)
- ⑤⑥ Thermistor

Distance from photosensitive area center to cap center
 $-0.3 \leq X \leq +0.3$
 $-0.3 \leq Y \leq +0.3$

	G12183-203K /-205K/-210K	G12183-220K /-230K
A	6.6 ± 0.2	6.7 ± 0.2

KIRDA0229EA

Information described in this material is current as of April, 2013.

Product specifications are subject to change without prior notice due to improvements or other reasons. This document has been carefully prepared and the information contained is believed to be accurate. In rare cases, however, there may be inaccuracies such as text errors. Before using these products, always contact us for the delivery specification sheet to check the latest specifications.

Type numbers of products listed in the delivery specification sheets or supplied as samples may have a suffix "(X)" which means preliminary specifications or a suffix "(Z)" which means developmental specifications.

The product warranty is valid for one year after delivery and is limited to product repair or replacement for defects discovered and reported to us within that one year period. However, even if within the warranty period we accept absolutely no liability for any loss caused by natural disasters or improper product use.

Copying or reprinting the contents described in this material in whole or in part is prohibited without our prior permission.